



CONNECT AND PROTECT

Connectors

12/2022

nvent

SCHROFF

Connectors, busbars

OVERVIEW

MAIN KATALOG

- Cabinets 1
- Wall mounted cases 2
- Accessories for cabinets and wall mounted cases .. 3
- Climate control .. 4
- Electronics cases 5
- Subracks/ 19" chassis 6
- Front panels, plug-in units 7
- Systems 8
- Power supply units 9
- Backplanes 10
- Connectors, front panel component system 11
- Appendix 12

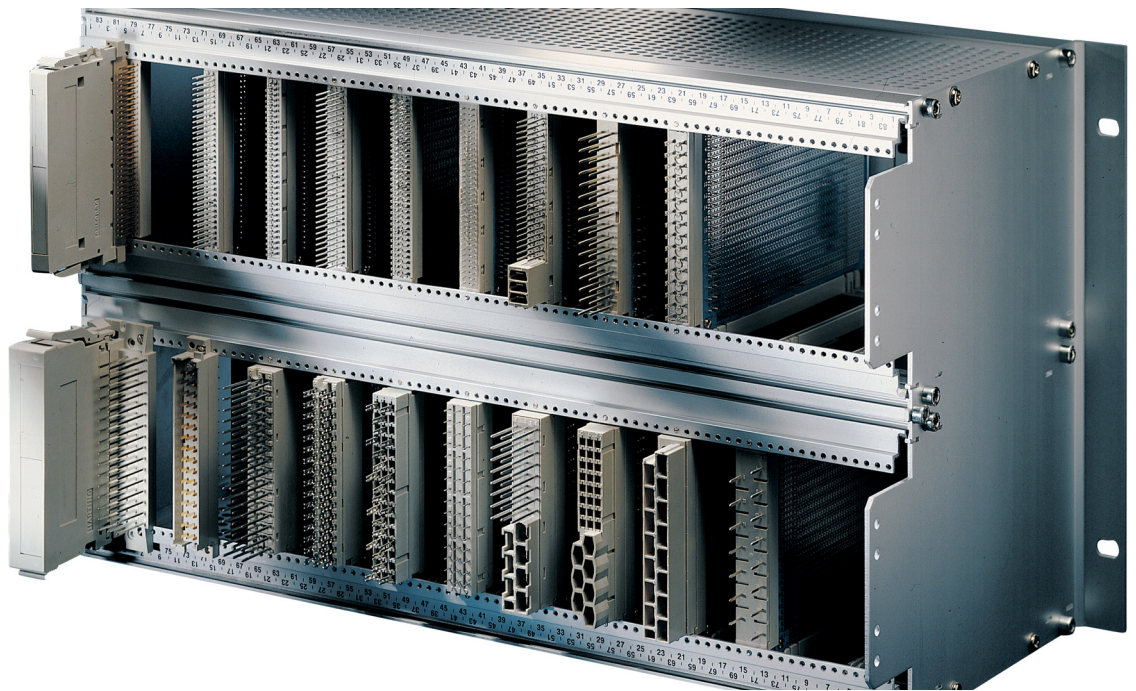

05592002

STANDARDS

- Connectors in accordance with:
IEC 60603-2 / DIN 41612

Requirements classes DIN 41612, Part 5

Requirements class 1

- 500 connector cycles
- 250 connector cycles, 21 day gas test with 10 ppm SO₂, measurement of contact resistance
- 250 connector cycles, then visual inspection, no abrasion of contact surface down to the base metal, no impairment of function

Requirements class 2

- 400 connector cycles
- 200 connector cycles, 4 day gas test with 10 ppm SO₂, measurement of contact resistance
- 200 connector cycles, then visual inspection, no abrasion of contact surface down to the base metal, no impairment of function

Requirements class 3

- 50 connector cycles, no gas test, then visual inspection, no impairment to function

Requirements class VG 95 324, part 1

- 500 connector cycles, then 1 day gas test with 10 000 ppm SO₂ and 1 day gas test with 10 000 ppm H₂S, then visual inspection, no abrasion of contact surface down to base metal, no impairment of function

MODIFICATIONS

Extended delivery program

- Connectors to IEC 60603-2 with requirements classes 1, 3 and defence equipment standard
Minimum quantity: 300 pieces
- Connectors with selective contacts
Minimum quantity: 500 pieces
- Complementary types to standard IEC 60603-2 („half” type)
Minimum quantity: 300 pieces
- Not catalogued connectors to IEC 60603-2
Minimum quantity: 300 pieces

Note:

Prices and delivery times available on request

Connectors, busbars

GENERAL TECHNICAL DATA

Contamination level 1

None or dry, non-conductive contamination. Contamination has no effect.

Contamination level 2

Non-conductive contamination only. Occasional transient conductivity due to condensation may occur. Contamination levels 3 and 4 are not taken into account as they do not apply to the connectors listed in this catalogue. The minimum creepage distances represented in the table relate to the CTI values of insulation group III a/b.

Reference voltage, minimum creepage distance and contamination level

Minimum creepage distance in mm

- Contamination level 1	0.09	0.125	0.14	0.18	0.2	0.22	0.25	0.28	0.32	0.42	0.56	0.75	1.0	0.3	1.8	2.4	3.2
- Contamination level 2	0.42	0.50	0.53	1.2	1.25	1.30	1.40	1.50	1.60	2.00	2.50	3.20	4.0	5.0	6.3	8.0	10

DERATING DIAGRAMS

Type B, C, R

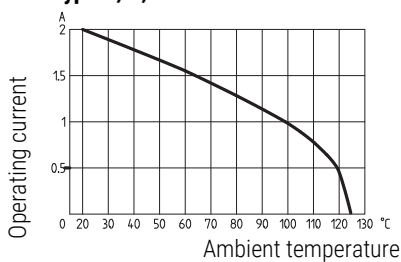

The current-carrying capacity of connectors is restricted by the thermal loading capacity of the materials, the contact elements - including connections - and insulation elements. The derating curve applies therefore for currents that may flow continuously (not intermittently) and simultaneously through each contact element of the connector without exceeding the maximum acceptable temperature. Measurement and control procedures in accordance with DIN 41 640, part 3.

Type D, E, F, G

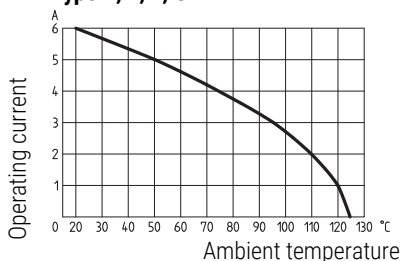

Type H

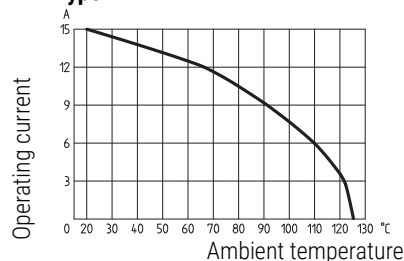

Type D, E, F, G

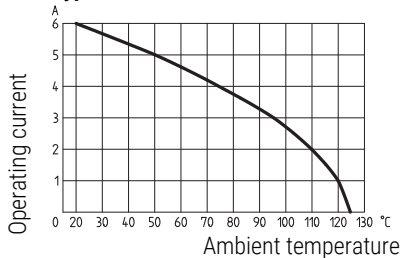

Type H

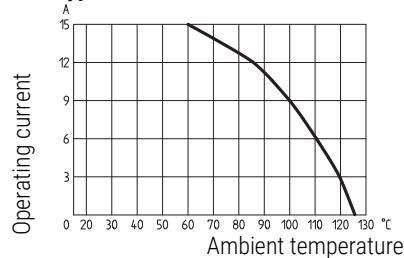

sva42501 sva42502 sva42503 sva42504 sva42505

Overview 11.3

Connectors

Connector types 11.4

Blank connector housings/locking levers 11.6

Keying/coding 11.7

Keying/coding pegs for codable female connectors 11.7

Keying/coding strips 11.8

PCB strengthening 11.8

Connectors, 3-pin 11.9

Busbars

4-pin for Faston connector 6.3 x 0.8 mm 11.10



PCB busbars 11.11

Busbars 11.11

Accessories – Connectors

OVERVIEW OF TYPES, CONNECTORS EN 60603 (DIN 41612)

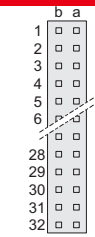
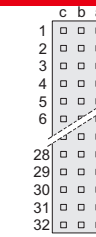
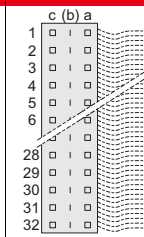
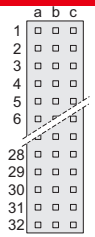
ORDER INFORMATION

Description	Number of contacts	Row assignment	Type B	Type C	Type C for ribbon cables	Type R	Type D
Drawing: View of rear of plug							
			1 piece	1 piece	1 piece	1 piece	1 piece
Male connector							
Solder pins, length 3 mm, 0.6 mm x 0.6 mm; angled	32	a, c	–	69001-826	–	–	69001-831
	64	a, b	69001-801	–	–	–	–
	64	a, c	–	69001-821	–	–	–
	96	a, b, c	–	69001-816	–	–	–
Female connector							
Wire-wrap pins, length 13 mm, 0.6 mm x 0.6 mm, straight;	32	a, c	–	69001-691	–	–	–
	64	a, c	–	69001-685	–	–	–
	96	a, b, c	–	69001-679	–	–	–
Wire-wrap pins, length 20 mm, 1 mm x 1 mm, straight;	32	a, c	–	–	–	–	69001-697
Solder pins, length 2.5 mm, Ø 0.6 mm, straight	64	a, b	69001-664	–	–	–	–
	64	a, c	–	69001-693	–	–	–
	96	a, b, c	–	69001-696	–	–	–
Solder pins, length 3 mm, 0.6 mm x 0.6 mm, angled	64	a, c	–	–	–	69001-976	–
	96	a, b, c	–	–	–	69001-728	–
Solder pins, length 4 mm, Ø 0.6 mm, straight	64	a, c	–	69001-678	–	–	–
	96	a, b, c	–	69001-677	–	–	–
Solder eye, length 5.5 mm	32	a, c	–	–	–	–	69001-698
Snap-on/screw-on for 64-pin cable	64	a, c	–	–	69005-596	–	–
Spring contacts for crimping, 0.14 - 0.5 mm ² , 50 pieces			–	–	–	–	21100-293
Spring contacts for crimping, 0.75 - 1.5 mm ² , 50 pieces			–	–	–	–	21100-294
Torx panhead screw M2.5 x 7, PU 100 pieces, for direct mounting on z-rail			24560-147	24560-147	24560-147	24560-147	24560-147

Technical Data	Type B	Type C	Type C for ribbon cables	Type R	Type D
Connector pitch	2.54 mm	2.54 mm	2.54 mm	2.54 mm	5.08 mm
Current load max. at 20 °C	2 A	2 A	1 A	2 A	6 A
Test voltage U _{eff} contact-contact	1 kV	1 kV	1 kV	1 kV	1.55 kV
Test voltage U _{eff} contact-earth	1.55 kV	1.55 kV	–	1.55 kV	1.55 kV
Contact resistance	≤ 20 mΩ	≤ 20 mΩ	–	≤ 20 mΩ	≤ 20 mΩ
Coding on the connector	–	–	–	–	–
Separate coding	yes	yes	yes	yes	yes
Contact surface	solidly gold-plated	solidly gold-plated	solidly gold-plated	solidly gold-plated	solidly gold-plated
Air gap contact-contact	>1.2 mm	>1.2 mm	–	>1.2 mm	>1.6 mm
Creepage distances contact-contact	>1.2 mm	>1.2 mm	–	>1.2 mm	>3.0 mm
Insertion and withdrawal forces	32-pin < 30 N; 64-pin < 60 N; 96-pin < 90 N		64-pin < 60 N	64-pin < 60 N; 96-pin < 90 N	32-pin < 40 N



NOTE

- Connectors are compliant with requirements class 2

Accessories – Connectors

OVERVIEW OF TYPES, CONNECTORS EN 60603 (DIN 41612)

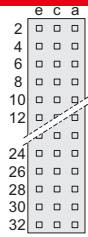
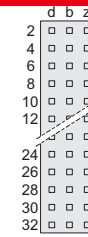
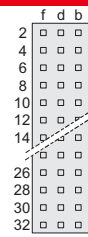
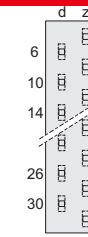
ORDER INFORMATION

Description	Number of contacts	Row assignment	Type E	Type F	Type G	Type H	Mixed type (M), type F and type H
Drawing: View of rear of plug							
			1 piece	1 piece	1 piece	1 piece	1 piece
Male connector							
Solder pins, length 2.9 mm, 0.6 mm x 0.6 mm; angled	32	z, b	-	69001-851	-	-	-
	32	z, d	-	69001-853	-	-	-
	48	a, c, e	69001-879	-	-	-	-
	48	z, b, d	-	69001-846	-	-	-
	64	z, b, d, f	-	-	69001-856	-	-
Solder pins, length 3 mm, 1.2 mm x 0.8 mm; angled; connector pins not protruding	15	z, d	-	-	-	69001-865	-
Solder pins, recessed, length 2.9 mm, 1.2 mm x 0.8 mm; angled	15	z, d	-	-	-	69001-860	-
FASTON connector 6.3 mm x 0.8 mm; straight	15	z, d	-	-	-	69001-866	-
Solder pins, length 2.9 mm, FØ 0.6 mm, H Ø 1.6 mm; angled	24+7-pin	z, b, d	-	-	-	-	-

Female connector							
Wire-wrap pins, length 22 mm, 1 mm x 1 mm; straight	32	z, b	-	69001-717	-	-	-
	48	a, c, e	69001-877	-	-	-	-
	48	z, b, d	-	69001-711	-	-	-
	64	z, b, d, f	-	-	69001-723	-	-
F: Wire-wrap pins, length 22 mm, 1 mm x 1 mm; H: FASTON connector 6.3 mm x 0.8 mm; straight	24+7-pin	z, b, d	-	-	-	-	69001-755
Solder pins, length 4 mm, 0.8 mm x 0.8 mm; straight	15	z, d	-	-	-	69001-981	-
Solder pins, length 4.5 mm, 0.4 mm x 0.6 mm; straight	48	z, b, d	-	69001-884	-	-	-
Solder pins, length 10 mm, 0.8 mm x 0.8 mm; straight	15	z, d	-	-	-	69001-980	-
Wiring with FASTON connector 6.3 mm x 0.8 mm; straight	15	z, d	-	-	-	69001-733	-
Solder eyes, length 9.5 mm	32	z, b	-	69001-718	-	-	-
	32	z, d	-	69001-722	-	-	-
	48	z, b, d	-	69001-712	-	-	-
F: Solder eyes; H: FASTON connector 6.3 mm x 0.8 mm; straight	24+7-pin	z, b, d	-	-	-	-	69001-944
Torx panhead screw M2.5 x 7, PU 100 pieces, for direct mounting on z-rail			24560-147	24560-147	24560-147	24560-147	24560-147

Technical Data	Type E	Type F	Type G	Type H	Mixed type (M), type F and type H	
Connector pitch	5.08 mm	5.08 mm	5.08 mm	10.16 mm	5.08 mm	10.16 mm
Current load max. at 20 °C	6 A	6 A	6 A	15 A	6 A	15 A
Test voltage U _{eff} contact-contact	1.55 kV	1.55 kV	1.55 kV	3.10 kV	1.55 kV	3.10 kV
Test voltage U _{eff} contact-earth	1.55 kV	2.50 kV	2.50 kV	3.10 kV	2.50 kV	3.10 kV
Contact resistance	≤ 20 mΩ	≤ 20 mΩ	≤ 20 mΩ	≤ 8 mΩ	≤ 20 mΩ	≤ 8 mΩ
Coding on the connector	-	-	-	yes	-	-
Separate coding	yes	yes	yes	yes	yes	yes
Contact surface	solidly gold-plated	solidly gold-plated	solidly gold-plated	hard silver-plated	solidly gold-plated	hard silver-plated
Air gap contact-contact	>1.6 mm	>1.6 mm	>1.6 mm	>4.5 mm	>1.6 mm	>4.5 mm
Creepage distances contact-contact	>3.0 mm	>3.0 mm	>3.0 mm	>8.0 mm	>3.0 mm	>8.0 mm
Insertion and withdrawal forces	48-pin < 75 N	32-pin < 50 N 48-pin < 75 N	64-pin < 100 N	15-pin < 90 N	24+7-pin < 85 N	

NOTE

- Connectors are compliant with requirements class 2

Accessories – Connectors

BLANK CONNECTOR HOUSINGS/LOCKING LEVERS

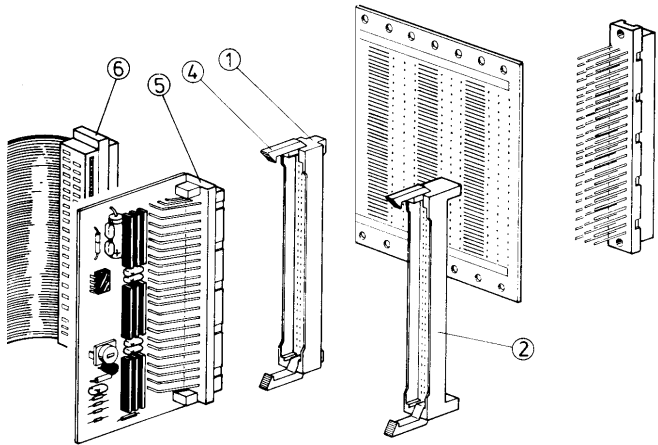

A4_2449

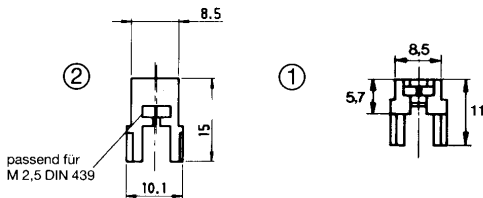
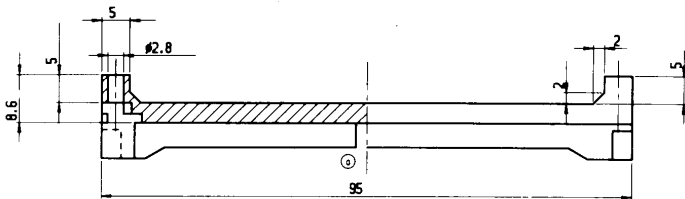
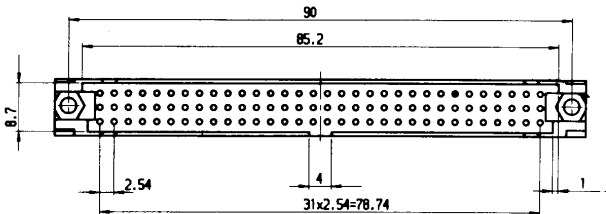

A3_401

- For types C and R
- The connector housing is fixed to the board with screws; it is pushed over wire wrap posts (e.g. on the rear of backplanes) and thereby forms a male connector
- Locking levers can be used e.g. to lock terminator boards or I/O connectors in place



ORDER INFORMATION

Item	Description	Qty/PU	Part no.
1	Housing with M 2.5 nuts, for posts 0.6 × 0.6 × 17 mm, backplane thickness 3.2 mm	1	29090-001
2	Housing with M 2.5 nuts, for posts 0.6 × 0.6 × 13 mm, backplane thickness 3.2 mm	1	29090-002
2	Housing with M 2.5 nuts, for posts 0.6 × 0.6 × 13 mm, backplane thickness 1.6 mm	1	29001-019
4	Locking lever for type R, grey	1	69001-995
4	Locking lever for type C, black	1	69001-106

NOTE

- 29090-001 is the replacement product for 69001-210 and 29001-015
- 29090-002 is the replacement product for 69001-814 and 29001-016
- 29001-019 is the replacement product for 69001-311

Accessories – Connectors

KEYING/CODING PEGS FOR CODABLE FEMALE CONNECTORS

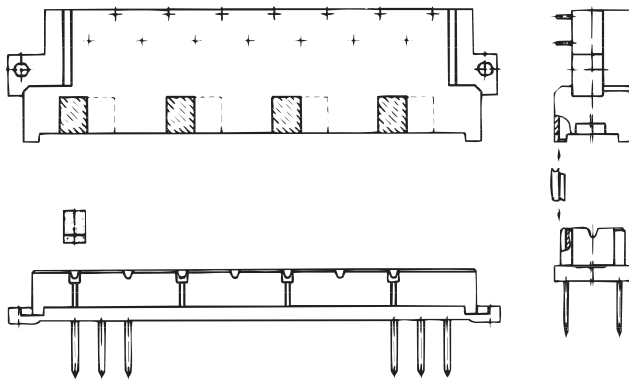

- For female connector type H
- Without loss of space
- Max. 70 keying/coding possibilities
- The keying/coding pegs are plugged into the female connector; the corresponding keying/coding fields (situated opposite) of the male connectors are broken out

ORDER INFORMATION

Description	Qty/PU	Part no.
Keying/coding pegs, PBTP, UL 94 V-0	40	21101-252

Keying/coding

- Keying/coding prevents plug-in units becoming mixed up
- Keying/coding for type H
 - Fixing direct onto plug by means of keying/coding peg in the female connector
- Keying/coding for all types in accordance with EN 60603 (DIN 41612)
 - Fixing via additional mounting of keying/coding strips

Keying/coding pegs	For female connector
Part no.	Part no.
	69001-733
21101-252	69001-980
	69001-981

Accessories – Connectors

KEYING/CODING STRIPS

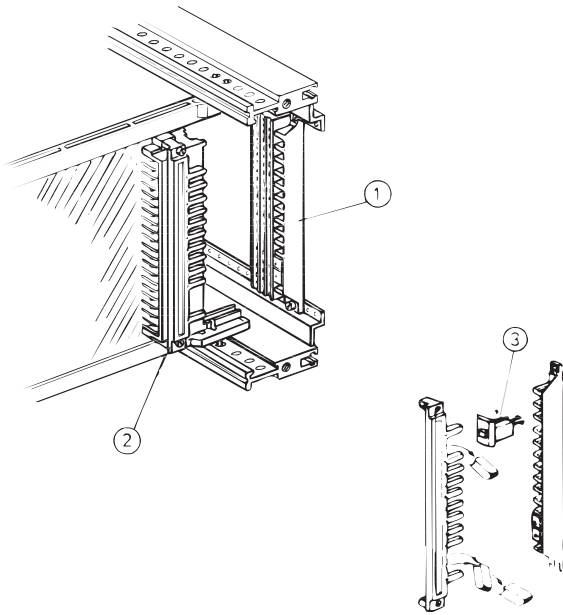
A4-2424

- For all types in accordance with EN 60603 (DIN 41612)
- Used with plug-in units to prevent mix-up
- Space for plugs with keying/coding strip:
 - 4 HP for types B, C, D, F, H
 - 5 HP for types E, G
- 66 keying/coding possibilities when two coding pins are used
- 924 keying/coding possibilities when six coding pins are used

ORDER INFORMATION

Item	Description	Qty/PU	Part no.
1, 2, 3	Contact strip PBTP, UL 94 V-0, 10 pieces, female strip, PBTP, UL 94 V-0, 10 pieces, keying/coding pins, PBTP, UL 94 V-0, 20 pieces	1	20800-042
1, 2, 3	Spacer element for types E, G	20	20800-036
3	Keying/coding pin	100	20800-078
Assembly kit Screw M2.5 × 18, PU 100 pieces			21100-404

NOTE

- For connectors types E and G spacers are always required

PCB STRENGTHENING (9 U)

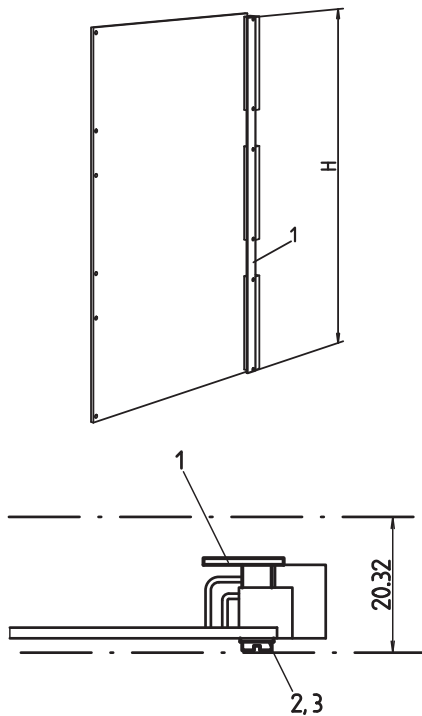
LKA42609
LKA42593

- Protects large PCBs from bending
- Creates an additional crossbar (in accordance with IEEE recommendations, P 896, Nubus, Multibus[®] II etc.) that links all connectors
- Fixing points match connectors in accordance with EN 60603 (DIN 41612), types B, R, C and D

DELIVERY COMPRISES (kit)

Item	Qty	Description
1	1	PCB strengthening, Al extrusion, anodised, cut edges plain; separator, stainless steel, riveted on
2	6	Cheesehead screw M 2,5 × 12, St, nickel-plated
3	6	Washer 2.6, St, nickel-plated

ORDER INFORMATION

Description	Height H mm	Part no.
For 9 U PCBs	361.6	20809-441

Accessories – Connectors

CONNECTORS, 3-PIN

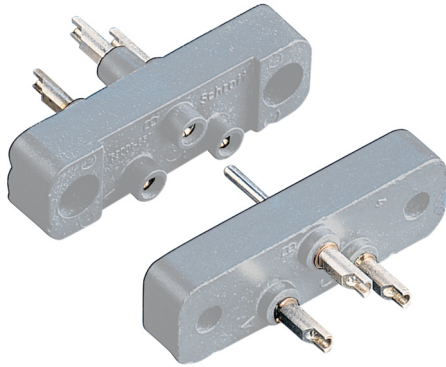

- Used for mains/line voltage supplies
- Male connector with advanced earth protection contact (B)

ORDER INFORMATION

Item	Description	Qty/PU	Part no.
1	Male connector	1	69001-651
2	Female connector strip	1	69001-652
3	Mounting plate for fixing in subrack, socket terminal strip mounts on z-rail (with threaded holes to EN 60603, DIN 41612)	1	30812-002

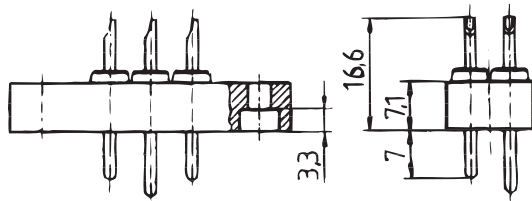

Dimensional drawing of multi-pin connector

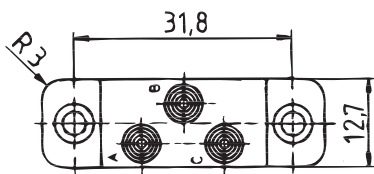
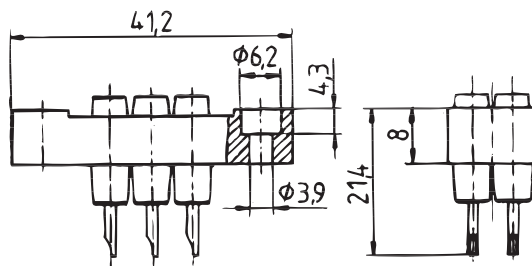

Dimensional drawing of socket terminal strip

TECHNICAL DATA

Nominal current per contact	10 A
Air gap	≥ 4.4 mm
Creepage distance	≥ 7.6 mm
Test voltage	3 kV (eff)
Contact resistance	approx. 10 mΩ
Connection	Solder eye connection up to 1 mm
Ambient temperature	23 °C ... 130 °C
Contact pins, sockets	galvanically silver-plated
Housing material	Keripol R gray (type 802 as per DIN 16911)
Flammability	UL 94-HB

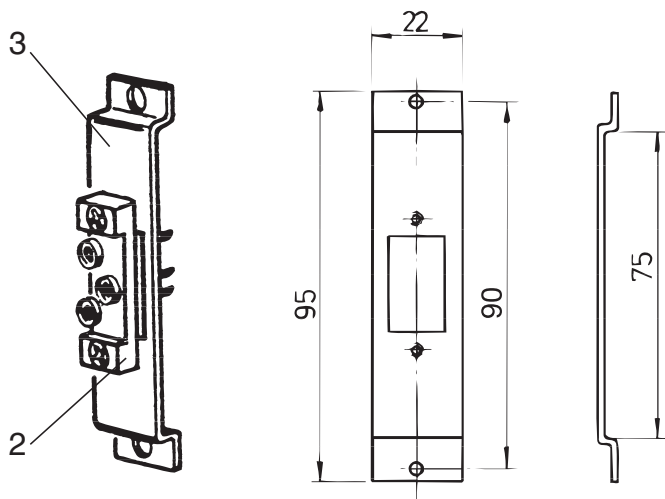

3: Mounting plate
2: Socket terminal strip

Dimension drawing of mounting plate

Accessories – Horizontal busbars

BUSBAR, 4-POLE, FOR FASTON CONNECTORS, 6.3 X 0.8 MM



- 24 connection points (4-poles, 6 connectors each)
- To supply mains voltage to 19" subracks
- Fixing in HP grid increments (spacing 15 HP), external dimension < 17 HP

DELIVERY COMPRISES

Item	Qty	Description
1	1	Busbar, 4-pole (for 6 Faston connectors 6.3 x 0.8 mm)

ORDER INFORMATION

Description	Part no.
Busbar, 4-pole, for Faston connectors, 6.3 x 0.8 mm	69001-073

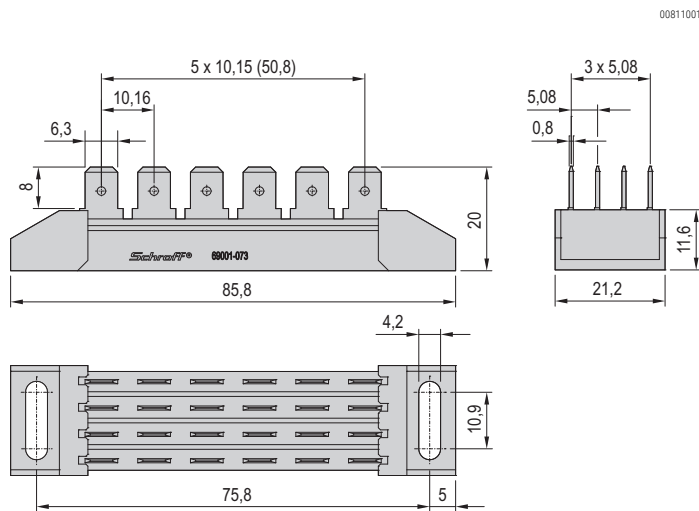

00811001

TECHNICAL DATA

Operating voltage	250 V _{AC}
Test voltage: Bar – Bar	3.5 kV _{eff}
Test voltage: Pin – Earth	5.0 kV _{eff}
Operating current at 20 °C per pin (= 6 connections)	$\sum I \leq 35$ A
Temperature range	-40 °C ... +100 °C
Material: Faston, busbars	CuZn, surface tin-plated
Material: insulating body	PC/ABS, UL 94-V0
Connector type	for Fastons 6.3 x 0.8 mm, 4-pin, 6 Fastons per pin
Connection pitch	5.08 x 10.16 mm

NOTE

- Other lengths, 2-pole and 3-pole versions, brass contacts available on request

00811050

Accessories – Horizontal busbars

PCB BUSBARS

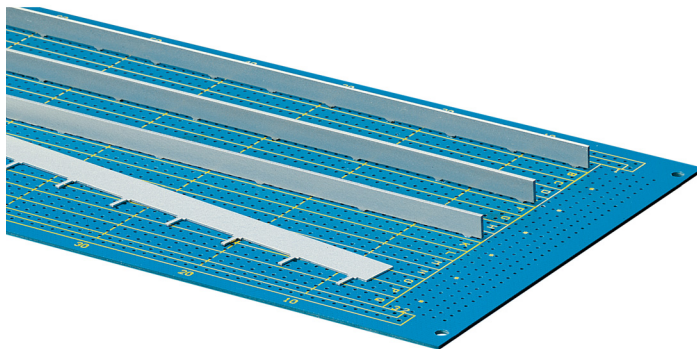

- Power distribution on printed circuit boards and backplanes
- Fault elimination
- Increases the stiffness of PCBs

ORDER INFORMATION

Width B HP	Length L mm	Dimension A mm	Part no.
3	220.3	14 × 15.24 = 213.36	30925-001
3	342.3	22 × 15.24 = 335.28	30925-002
4	210.2	10 × 20.32 = 203.2	30925-003
4	332.1	16 × 20.32 = 325.12	30925-004
5	210.2	8 × 25.4 = 203.2	30925-005
5	337.2	13 × 25.4 = 330.2	30925-006

Delivery is exclusively in Standard Pack Quantity (SPQ): Please order at least 10 pieces or a multiple. Pricing is per individual item.

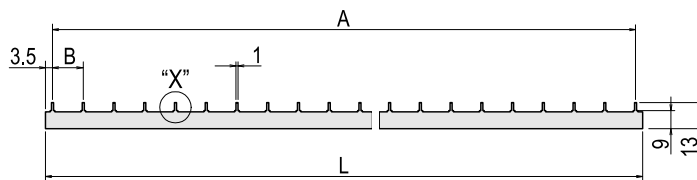

00892008

TECHNICAL DATA

Conductor material	E-Cu, tin-plated
Pin dimensions	0.8 × 1.0 mm
Max. operating current	30 A
DC resistance	2.5 mΩ/m

NOTE

- Special designs available on request

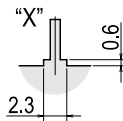

A41743

SOLDER STRIP CONDUCTOR

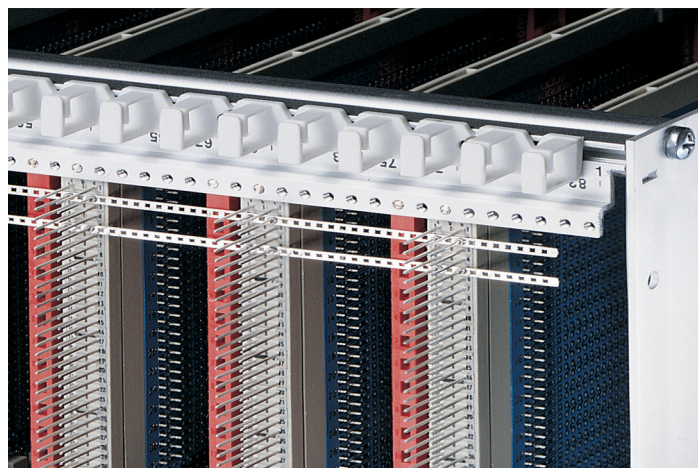

- Efficient linking of connections in the same grid and with the same potential
- Also suitable for EN 60603 (DIN 41612) connectors with wire-wrap pin

ORDER INFORMATION

Connection type	A mm	B mm	C mm	D mm	n	Qty/PU	Part no.
Wire-wrap pins 0.6 × 0.6 mm	1.14	0.9	2.54	2.3	168	1	60800-064
Wire-wrap pins 1.0 × 1.0 mm	1.65	1.4	5.08	3.2	84	1	60800-080

TECHNICAL DATA

Conductor material	E-Cu F30, tin-plated
Max. operating current wire-wrap pins 0.6 × 0.6 mm	≤ 4 A
Max. operating current wire-wrap pins 1.0 × 1.0 mm	≤ 4 A

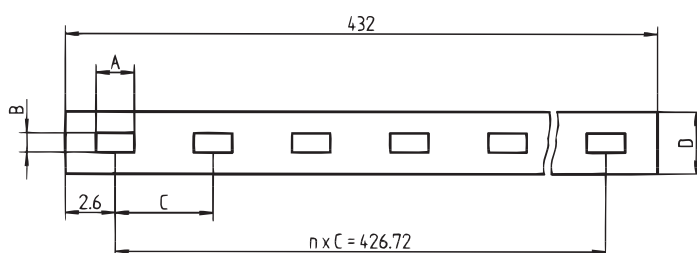

00892016

AZA42390

North America

Warwick, RI, USA

Tel +1.401.738.1722

San Diego, CA, USA

Tel +1.858.740.2400

Europe, Middle East & India

Straubenhardt, Germany

Tel +49 7082 794 0

Betschdorf, France

Tel +33 3 88 90 64 90

Warsaw, Poland

Tel +48 22 209 98 35

Hemel Hempstead,

Great Britain

Tel +44 1442 24 04 71

Lainate, Italy

Tel +39 02 932 714 1

Dubai, United Arab Emirates

Tel +971 4 82 38 666

Bangalore, India

Tel +91 80 6715 8900

Istanbul, Turkey

Tel +90 541 368 0941

Asia Pacific

Shanghai, China

Tel +86 21 2412 6943

Singapore

Tel +65 6768 5800

Shin-Yokohama, Japan

Tel +81 45 476 0271

Our powerful portfolio of brands:

CADDY ERICO HOFFMAN RAYCHEM SCHROFF TRACER



[nVent.com/SCHROFF](https://www.nVent.com/SCHROFF)